



DR Series Time Clocks Product Manual

DR2000

Voice Control and Facial Recognition

DR2500

Voice Control, Facial Recognition + Temperature Reader

CONTENTS

01	INTRODUCTION	3
02	YOUR UATTEND ACCOUNT	4
03	DEPARTMENTS	6
04	EMPLOYEES	7
05	TEMPERATURE READER SETTINGS	8
06	TIME CLOCK ACTIVATION	10
07	WALL MOUNT	13
08	FACE TEMPLATES	14
09	MENUS	15
10	ADD/REMOVE TEMPERATURE READER	18
11	TROUBLESHOOTING	20
12	LIMITED WARRANTY	21
13	SAFETY INFORMATION	24



01

INTRODUCTION

Setting up your uAttend DR2000/DR2500 requires connecting your time clock to the cloud portal.

First, we'll set up the cloud, then the time clock.

Once you've completed the following six easy steps, your employees can start punching in!

1. **CREATE YOUR ACCOUNT**

 2. **ADD DEPARTMENTS AND EMPLOYEES**

 3. **CHOOSE TEMPERATURE READER SETTINGS**

 4. **ACTIVATE YOUR TIME CLOCK**

 5. **MOUNT YOUR TIME CLOCK**

 6. **REGISTER EMPLOYEE FACES**

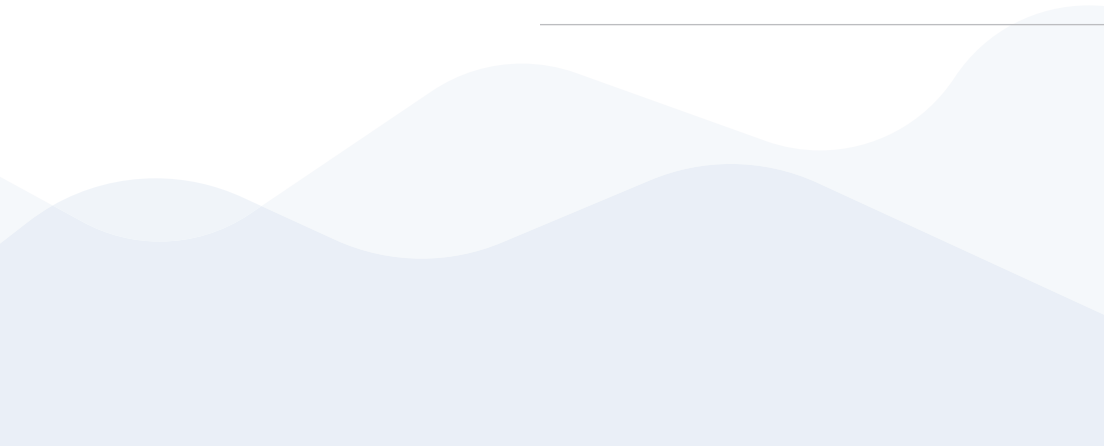
- 

02

CREATE YOUR uATTEND ACCOUNT

⚠ Before you can set up your new uAttend Time Clock, you will need to set up your uAttend Cloud Account.

Open your web browser and visit www.TrackMyTime.com/signup then follow the prompts.

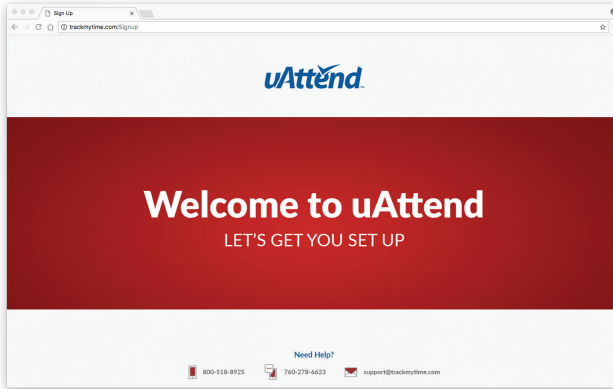

Here are some helpful tips to make the setup as smooth as possible.

Your **Dealer ID** will be found on the back of your **Quick Start Guide**. If the **Dealer ID** is missing, please contact **Customer Support**.

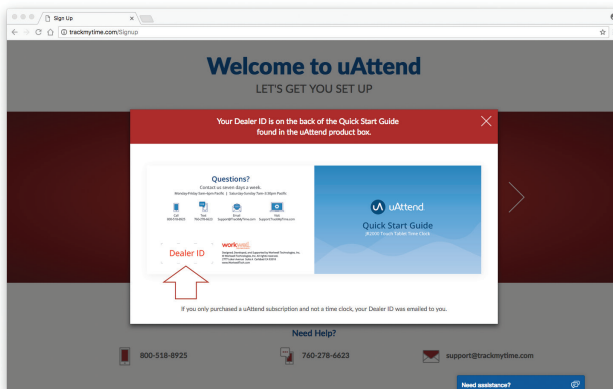

?

QUESTIONS? Call 800-518-8925 or email support@trackmytime.com

When selecting your plan size, keep in mind that your **employees** are your hourly workforce.

Supervisors (not paid hourly) and administrators are not included in this number. Your plan is month-to-month and can be changed at any time.

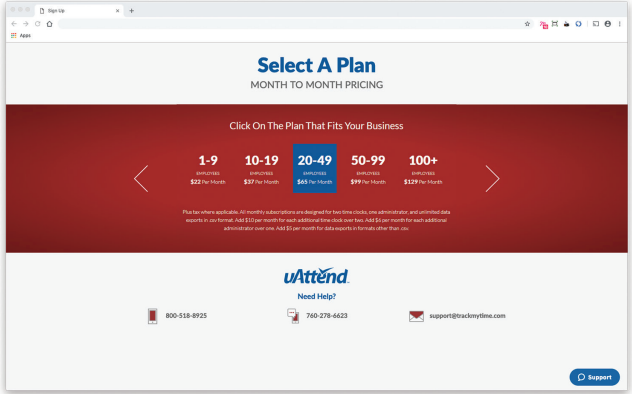

Your login URL is going to become the **“web address”** for your company's uAttend Portal. For example, “The Great Cookie Co” may become **trackmytime.com/gr8cookieco**

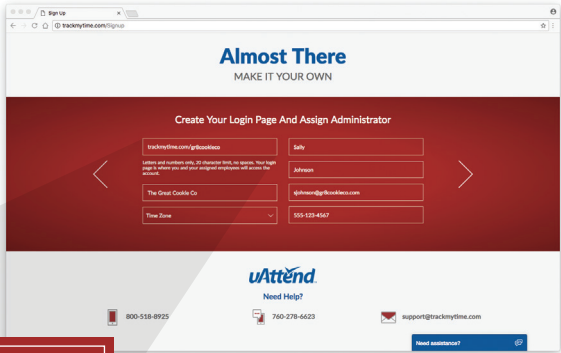

trackmytime.com/gr8cookieco

03

ADD DEPARTMENTS

Departments are used to group employees together within the uAttend system. The uAttend Setup Wizard will create a default department, which you can modify as needed. You can create more departments within your account and choose other department settings, such as overtime and punch rounding rules.

1. Select the Departments tab on your Dashboard

2. Select "+Add Department"

3. Create a Department Code

The Department Code is used as a reference on employee time cards to ensure that hours are appropriately allocated to the correct departments. For example, the code for "Sales" can be, "SLS."

The screenshot shows the 'Add Department' form with the following details:

- General**
 - Code: SLS
 - Department Name: Enter Name
 - Punch Rounding: OFF
 - Employees punch for breaks?: NO
 - Paid break/duration: OFF
 - Employees punch for Lunch?: NO
 - Lunch deduction/duration: OFF
- Overtime**
 - Weekly/BI-weekly Overtime: OFF
- Advanced**
 - Day Changes At: 12:00 AM
 - Maximum Shift: 14
 - New Shift Starts: 3
 - Night Shift?: NO

Buttons at the bottom: CANCEL, SAVE & ADD NEW, SAVE & CONTINUE, SAVE & CLOSE.

4. Enter the full Department Name

Specify additional department settings on this screen now, or enter that information later.

5. Select...

- "Save & Add New" to add a new department.
- "Save & Continue" to add more rules and policies.
- "Save & Close" to move to the next step.



QUESTIONS? Call 800-518-8925 or email support@trackmytime.com

04

ADD EMPLOYEES

The number of employees you can add to your account is limited by the plan size you have chosen. Add and assign employees to your departments in the uAttend Setup Wizard or simply add them later within your account.

Change the size of your plan at any time by selecting your user icon in the upper right corner of your uAttend Portal, then selecting **"My Account"** from the drop down menu.

1. Select the Users tab on your Dashboard

2. Select "Add User"

3. Assign the user a role, then add their first and last name

Employees are the portion of your workforce that use the time clock to track their time.

Supervisors can view and edit time cards, but do not punch in and out of the time clock.

Administrators have full access to the account and its settings. Additional administrators can be added for \$6 per month, per administrator.

4. Select...

- a. **"Save and Continue"** to set up the employee's profile.
- b. **"Save and Close"** to move on to the next steps.

You can add more details by going back to that user's profile at any time.

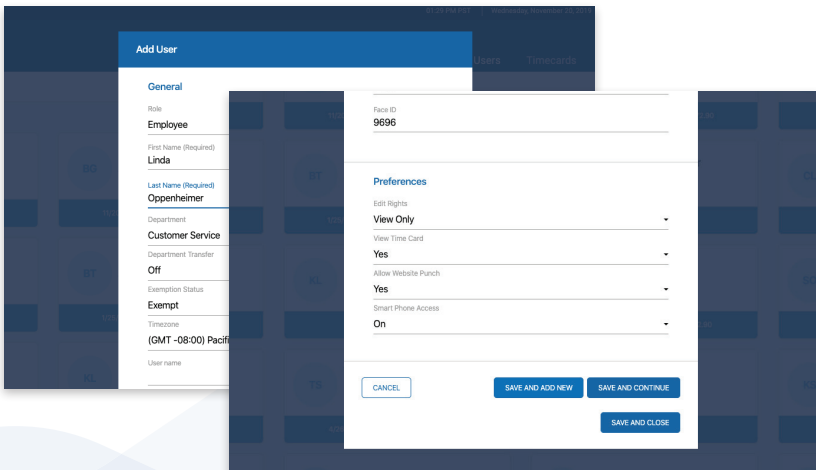

05

CONFIGURE TEMPERATURE READER SETTINGS

Before the time clock can scan employees' temperatures, you need to configure and enable the temperature reader settings. Once enabled, the time clock will record temperatures on the first punch-in of the day. You can apply default and individual temperature reader settings by following the steps listed below. **The following instructions are applicable only for devices with a temperature reader.**

DEFAULT TEMPERATURE READER SETTINGS

1. Set up your default temperature reader settings by selecting **Settings > Punch Management**. Then, select **Edit** next to **Temperature Reader Settings** and fill out the following information.

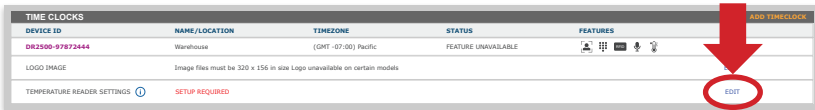

2. **Enable/Disable:** The temperature reader is enabled by default. Toggling off this setting will disable the temperature reader on all time clocks using default settings.
3. **Temperature Unit:** Fahrenheit or Celsius.
4. **Temperature Lockout Threshold:** The time clock will lockout employees who meet or exceed this number.
5. **Temperature Reporting:** Choose how employee temperatures will be recorded in your uAttend account as either "Actual Temperature" or "Pass/Fail."
6. **Temperature Lockout Message:** This message will display on the time clock screen if an employee is locked out of punching.
7. **Apply Default Settings:** Select which clocks will use default settings.
8. **Save.**
9. If you have multiple time clocks on your account and would like to apply Individual Temperature Reader Settings, proceed to the next section.



QUESTIONS? Call 800-518-8925 or email support@trackmytime.com

INDIVIDUAL TIME CLOCK TEMPERATURE READER SETTINGS

Individual temperature reader settings are optional. If you have multiple time clocks and at least one requires different temperature reader settings from your default selection, proceed with the next steps.

1. From the **Settings > Punch Management** screen, select **Edit** next to the name of the time clock you wish to apply individual settings.

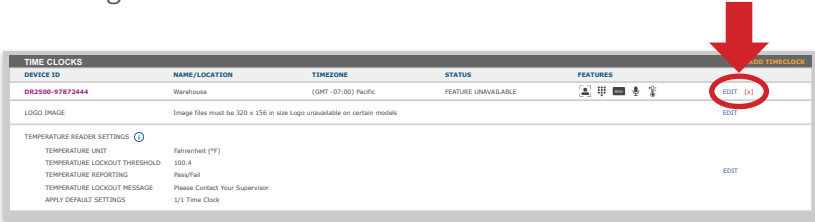

2. **Enable/Disable:** The temperature reader is enabled by default. Toggling off this setting will disable the temperature reader on this time clock.
3. **Use Default Settings:** Toggle on if you decide later that you want this clock to use default settings.
4. Fill out the rest of the settings by following steps 3-6 in the previous **Default Temperature Reader Settings** section.
5. **Save.**

Please note: Workwell is not advertising its products for use in the medical industry or for medical purposes. Our products are not intended to diagnose or exclude contagions such as COVID-19, SARS, or any other medical condition and should not be used as such. Our products are intended to serve as a first-line filter by assisting an organization and its employees in identifying those employees who may have an elevated body temperature. While our products may archive readings for reporting and audit purposes, it is solely the responsibility of the organization to communicate the use of the information to its employees, to obtain any necessary consent from its employees and to determine how the information is used. The organization should not rely solely on our products for making such a determination. Various environmental and methodological factors can impact thermal imaging; therefore, the readings from our products should not be relied upon as the sole determinant of a person's body temperature. Competent medical advice and further checks should be sought if there are concerns regarding an employee's health or possible illness. Workwell hereby disclaims all liability with respect to the conditions and limitations described in this paragraph.

06

ACTIVATE YOUR TIME CLOCK

The DR series time clocks allow for easy set up with LAN or WiFi connection.

ACTIVATION VIA LAN

1. Attach a LAN cable to your clock and router, then plug your clock into a power outlet

a. Follow the onscreen prompts to confirm your network selection.

b. The clock will check for any needed updates once the connection is established to ensure you have the most up-to-date version of the clock firmware.

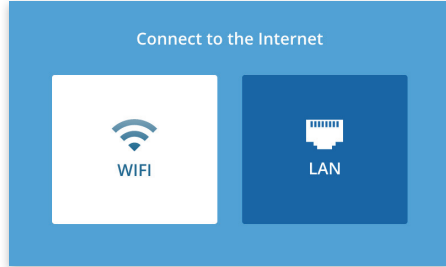

2. Enter your uAttend Company ID

a. This ID can be found in the upper right corner of your uAttend Web Portal. If you do not have an account, please set one up as outlined in Section 2 of this manual.

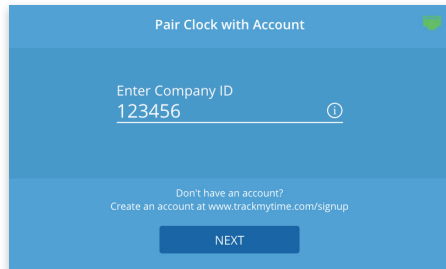

3. Enter the 2-factor Authentication Code, emailed to your uAttend Account administrator's email address

a. This helps keep your account secure by preventing additional clocks from being added to your account without your permission.

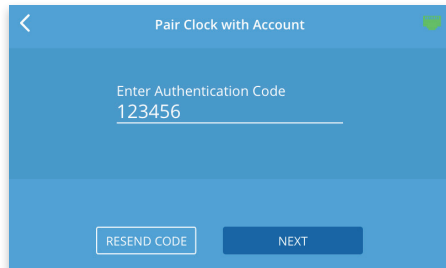

QUESTIONS? Call 800-518-8925 or email support@trackmytime.com

4. **Confirm that your account information is correct**
5. **Select a time zone based on the location of the clock**
6. **Set your Administrator Passcode**

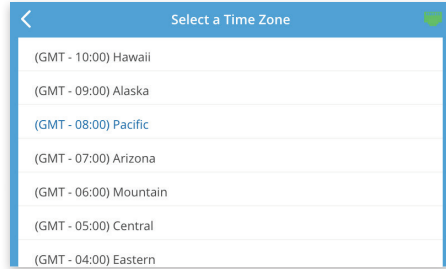

- a. This 5-digit code will be used to access administrator-only functions. If you ever lose it, it can be recovered by visiting your uAttend Account.

7. Clock setup is now complete!

ACTIVATION VIA WIFI

1. Plug your clock into a power outlet

- a. Follow the onscreen prompts to select your WiFi Network.
- b. Enter your password onscreen.
- c. The clock will check for any needed updates once the connection is established to ensure you have the most up-to-date version of the clock firmware.

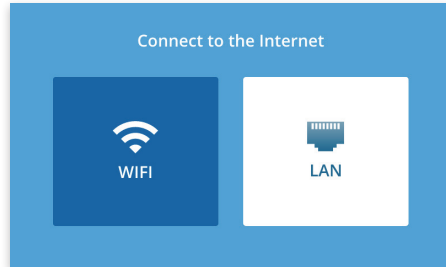

2. Enter your uAttend Company ID

- a. This ID can be found in the upper right corner of your uAttend Web Portal. If you do not have an account, please set one up as outlined in Section 2 of this manual.

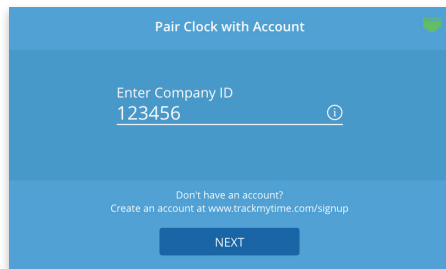

3. Enter the 2-factor Authentication Code, emailed to your uAttend Account administrator's email address

- a. This helps to keep your account secure, by preventing any additional clocks from being added to your account without your permission.

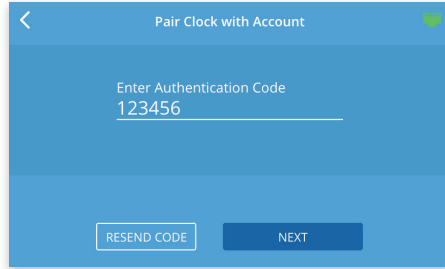

4. Confirm that your account information is correct

5. Select a time zone based on the location of the clock

6. Set your Administrator Passcode

- a. This 5-digit code will be used to access administrator-only functions. If you ever lose it, it can be recovered by visiting your uAttend Account.

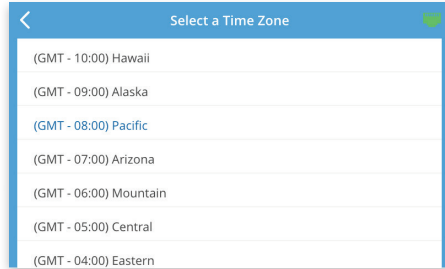

7. Clock setup is now complete!



07

WALL MOUNT

Everything you need to mount your timeclock to the wall is included in your purchase: metal back plate, LAN cord, power adapter, four drywall anchors, four screws, and two small bracket screws. You will need your own Phillips-head screwdriver.

CHOOSING A LOCATION

For best optimization of voice and facial recognition, mount your time clock in an area that has:

- Minimal background noise to avoid interference with voice commands.
- Ample ambient lighting (without back-lighting) for successful facial recognition.

MOUNTING YOUR TIME CLOCK ONTO YOUR WALL

1. Select a location for your time clock near a power outlet and LAN port (if applicable).
2. Place the provided mounting template against the wall. Drill holes through the targets using a 1/4" (6.35mm) drill bit.
3. Insert drywall anchors into the center of the wall marks (Fig. A).
4. Align the metal back plate with the holes. Ensure that the prongs are facing away from the wall, then secure the back plate to the wall with the screws provided.
5. Attach the power adapter and the LAN line (if applicable).
6. Align the two slots on the back of the clock with the two prongs on the back plate. Push down slightly to ensure the clock is securely fastened (Fig. B).
7. Optionally screw the time clock to the metal back plate with the included bracket screws at the bottom of the time clock (Fig. B).

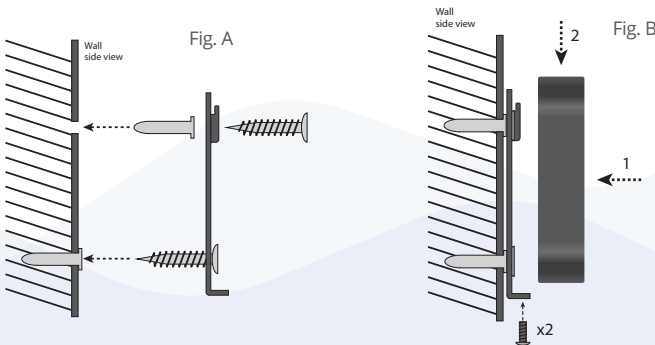

08

FACE TEMPLATES

Once an employee has registered their face on one of the clocks, they will be able to use facial recognition authentication on all DR clocks under your account.

REGISTRATION TIPS:

- Employees should not wear face masks while registering. Once registered, employees can successfully authenticate even when wearing a face mask.
- Register employee faces in a location with bright ambient lighting. Dim lighting, back lighting or shadows may result in failed scans.

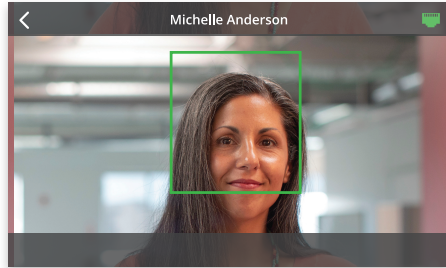

REGISTERING FACE TEMPLATES

Before registering face templates, please ensure you have added the employee to your online uAttend account as outlined in Section 4.

1. Tap the PIN icon in the bottom right-hand corner of the time clock screen and enter your Administrator PIN. This is the PIN which you chose during device setup. It can be found in your clock details at **Settings > Punch Management** in your online account.
2. Select **Employee** in the time clock User Menu.
3. Select the employee you wish to register face templates for from the list provided.
4. Follow the onscreen prompts to scan the employee's face.
5. Repeat steps 1-4 for every employee who will authenticate with facial recognition.



QUESTIONS? Call 800-518-8925 or email support@trackmytime.com

09

ADMINISTRATOR MENU OPTIONS

The **Administrator** menu can be accessed with the **Administrator PIN** you chose during device setup. It can be found in your clock details at **Settings > Punch Management** in your online account.

Here are the different settings and tools within the Administrator menu:

1. Employee

Displays a searchable list of Employees by name.

- a. Select an Employee to manage or register face templates.

2. Device

a. Software Updates

- i. Tap the **Software Update** option from the **Device Menu**.

1. The clock will check for available updates. The clock's current software version will also display on this screen.

- ii. If there are updates available, you can select to **Update** now or later.

1. After choosing to update the software, the clock will download the update and

automatically restart to apply the update. If the update was not successful, then the time clock will display messaging accordingly on the screen. If this occurs, you'll have the options to choose **Update Later** or **Please Try Again** on the following screen.

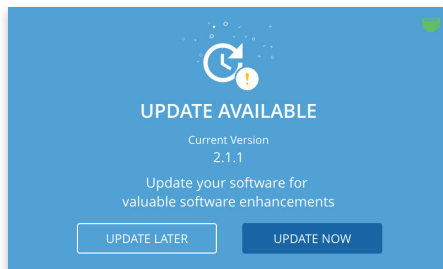
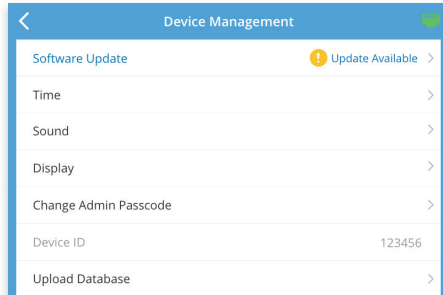
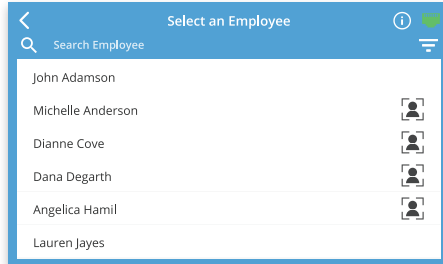

b. Time

- i. **Time Zone** – The Time Zone the clock is located in.
- ii. **Time Format** –
 1. 12 hour – Standard 12-hour format with AM and PM settings.
 2. 24 hr – Also known as Military time.

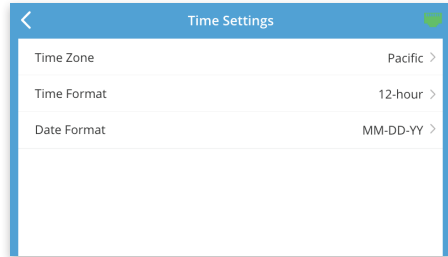

c. Sound

- i. **Key Sounds** – Turn sounds for key presses on or off.
- ii. **Volume Level** – The volume setting for all sounds on the clock.
- iii. **Time Clock Voice** – Select the voice for confirmations on punching or disable this entirely.

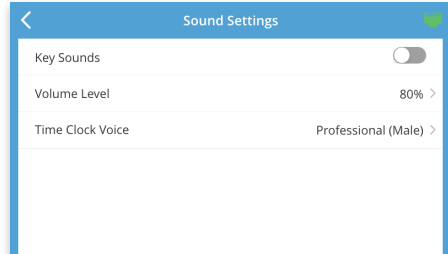

d. Display

- i. **Brightness Level** – The default brightness level of the screen.
- ii. **Sleep Mode** – How long before the screen dims when idle.
 1. Note: tapping the screen will restore the brightness level.

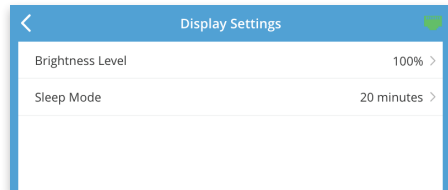

e. Change Admin Password

- i. Enter the current **Admin PIN** to verify authorization, then tap next.
- ii. Enter the new **PIN** for the time clock, hide the onscreen keyboard, and tap next.
- iii. A confirmation screen should be displayed.

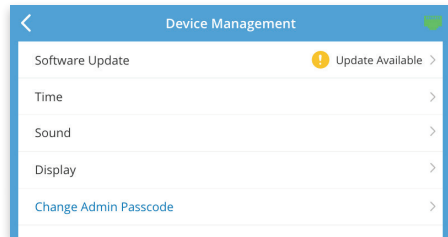

f. Device ID

The number used to identify the clock in the uAttend portal.

g. Upload Database

This will send your database to Workwell Technologies for diagnostic purposes.

3. Network

a. Network Connection:

i. WiFi

1. Scroll the list of available networks to locate your network's name.
2. Use the onscreen keyboard to enter your WiFi password and press **Next**.
3. The screen will display a confirmation that the clock is connected to your WiFi network.

ii. LAN

1. The configuration for your **LAN** network will be displayed on this screen.

4. Support

- a. A screen will display showing the methods for requesting support.

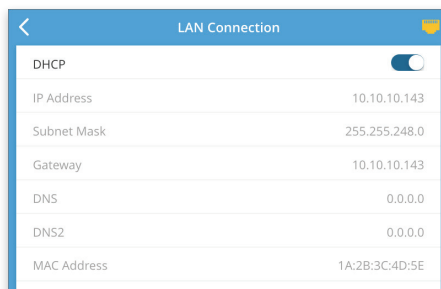
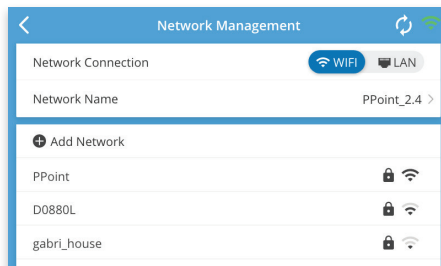
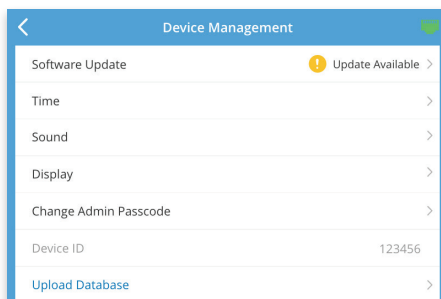

10

ADD/REMOVE TEMPERATURE READER

Unless you've purchased a temperature reader to add to your DR2000 or you are troubleshooting an issue, there should be no need to add or remove the temperature reader from your device. Should you need to add or remove the temperature reader, follow the simple steps below.

ADDING THE TEMPERATURE READER

1. Disconnect your device from the power outlet.
2. Connect the temperature reader to the top of the time clock.
3. Plug the cord attached to the temperature reader into the corresponding port on the time clock.
4. Reconnect your device to the power outlet to turn on.

REMOVING THE TEMPERATURE READER

1. Disconnect your device from the power outlet.
2. Unplug the cord attached to the temperature reader from the time clock.
3. Disconnect the temperature reader from the top of the time clock.
4. Reconnect your device to the power outlet to turn on.

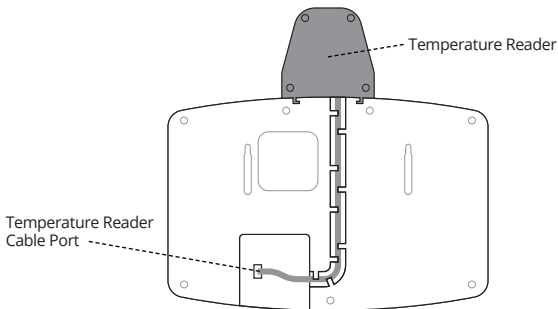

Please note: Workwell is not advertising its products for use in the medical industry or for medical purposes. Our products are not intended to diagnose or exclude contagions such as COVID-19, SARS, or any other medical condition and should not be used as such. Our products are intended to serve as a first-line filter by assisting an organization and its employees in identifying those employees who may have an elevated body temperature. While our products may archive readings for reporting and audit purposes, it is solely the responsibility of the organization to communicate the use of the information to its employees, to obtain any necessary consent from its employees and to determine how the information is used. The organization should not rely solely on our products for making such a determination. Various environmental and methodological factors can impact thermal imaging; therefore, the readings from our products should not be relied upon as the sole determinant of a person's body temperature. Competent medical advice and further checks should be sought if there are concerns regarding an employee's health or possible illness. Workwell hereby disclaims all liability with respect to the conditions and limitations described in this paragraph.



QUESTIONS? Call 800-518-8925 or email support@trackmytime.com

11

TROUBLESHOOTING

See the following table for help with the error messages that you might encounter with your DR Series Time Clock.

ERROR MESSAGE	NOTES
CANNOT CONNECT TO INTERNAL NETWORK	If clock is not currently plugged into any networking device or the networking device it is plugged into is not turned on or functioning.
SORRY, DEALER ID NOT FOUND	TrackMyTime.com will report this error if the Dealer ID you entered is not valid. Please contact uAttend Support for assistance.
CANNOT CONNECT TO UATTEND SERVER	If a clock is placed into a functioning network, but is not able to communicate with the uAttend server.
CANNOT ACCESS THE INTERNET	If a clock is connected to the local network, but is unable to communicate with the Internet.
CANNOT LOCATE UATTEND SERVER USING DNS	If a clock is not able to properly resolve the hostname of the domain it is trying to contact because it either does not have a valid DNS server IP address to contact or the DNS server it is contacting cannot properly resolve the hostname for the server.
NO RESPONSE FROM DHCP SERVICE	If a clock is placed into a functioning network, is set to use DHCP, but gets no responses when attempting to contact a DHCP server during the Discover process of DHCP.

12

uATTEND DEVICE LIMITED WARRANTY

This Warranty covers all uAttend Devices and any Devices which may now or in the future be connected to your uAttend Account.

- A. **Warranty and Warranty Periods.** Workwell Technologies, Inc. (“WWTech”) warrants only to the original Purchaser that the Device will be free from defects in material and workmanship for the time during which (i) the original Purchaser subscribes to the uAttend System, and (ii) until such time the Device has been replaced (the “Warranty Period”).
- B. **WWTech’s Obligation Under Warranty.** WWTech’s sole obligation under the above warranty shall be to repair or replace Devices and parts during the Warranty Period. WWTech does not assume responsibility for delays in replacement or repair of products or parts. WWTech may, at its sole discretion, replace Devices with refurbished Devices. This warranty gives end users specific legal rights, and particular end users may also have other rights which may vary from jurisdiction to jurisdiction.
- C. **DISCLAIMER OF ALL OTHER WARRANTIES.** NO OTHER WARRANTIES, EXPRESSED OR IMPLIED, ARE GIVEN, AND WWTech EXPRESSLY DISCLAIMS ALL OTHER WARRANTIES, INCLUDING AND WITHOUT LIMITATION, THE IMPLIED WARRANTIES OF MERCHANTABILITY AND FITNESS FOR A PARTICULAR PURPOSE. Some jurisdictions do not allow limitations on how long an implied warranty lasts, so the above limitation may not apply to particular end users.
- D. **Limitations.** No salesperson, representative, or agent of WWTech is authorized to make any guaranty, warranty, or representation that contradicts the terms contained in this Limited Warranty. Any waiver, alteration, addition, or modification to the warranties contained herein must



be in writing and signed by authorized representatives of WWTech to be valid, binding, and enforceable. WWTech does not assume responsibility for any specific application to which any products or parts are applied including, but not limited to, compatibility with other equipment. All statements, technical information, or recommendations relating to the products or parts are based upon tests believed to be reliable, but do not constitute a guaranty or warranty. WWTech SHALL NOT UNDER ANY CIRCUMSTANCES WHATSOEVER BE LIABLE TO ANY PARTY FOR LOSS OF PROFITS, DIMINUTION OF GOOD WILL, OR ANY OTHER SPECIAL, CONSEQUENTIAL, OR INCIDENTAL DAMAGES WHATSOEVER WITH RESPECT TO ANY CLAIM IN CONNECTION WITH WWTech PRODUCTS AND/OR PARTS. Some jurisdictions do not allow the exclusion or limitation of incidental or consequential damages, so the above limitation or exclusion may not apply to particular end users.

- E. What May Void the Warranty. This Limited Warranty shall be null and void in the following circumstances:
1. Modification or repair by the end user or any non-authorized WWTech service provider; or
 2. Improper use or installation, or damage by accident or neglect, by the end user or any third party, or intentional damage by the end user or any third party; or
 3. Failure of the end user or any third party to exercise caution to protect from electrostatic discharge damage and adverse temperature, or physical abuse; or
 4. Failure by the end user to follow the Return Appointment Process set forth below.

- F. Return Appointment Process. As a condition precedent to the above Limited Warranty, the end user must:
1. Obtain a return material authorization (RMA) from WWTech, which will include an RMA number that must be prominently displayed on the outside of the shipping container. Returns without an RMA number may be rejected by WWTech and immediately returned to end user, freight collect.
 2. Ship the items being returned to WWTech, freight prepaid, together with a written description of the claimed defect.
 3. Pack the items being returned in the original packing carton or equivalent. Damage in transit is end user's responsibility and may be cause to void the warranty claim.
- G. Transportation Costs. WWTech will pay surface freight to return products covered by this Limited Warranty. However, if WWTech determines in the exercise of its reasonable but sole discretion that the product or part returned for warranty service is not defective, or does not otherwise qualify for warranty service, the end user shall be liable for all costs of handling and transportation.



13

uATTEND SAFETY INFORMATION

IMPORTANT SAFEGUARDS FOR SAFE OPERATION & USE

SAVE THESE INSTRUCTIONS.

THIS PRODUCT IS FOR COMMERCIAL USE ONLY.

The time clock is an electrical device. In order to reduce the risk of fatal electrical shock and fire, basic safety precautions should be followed, including the following:

1. Read all instructions before operating.
2. This time clock must be properly installed and located in accordance with these instructions before used.
3. Do not use outdoors.
4. Do not expose to water or any liquid.
5. Do not place objects into the time clock.
6. For best operation, plug the time clock into its own electrical outlet.
7. Do not operate the time clock with a damaged cord or plug.
8. If an extension cord is used, the marked electrical rating of the extension cord should be at least as great as the electrical rating of the time clock.
9. Plug the time clock into a surge protector or uninterruptible power supply (UPS). If a surge protector is not used and there is a power surge, your warranty may be voided.



CAUTION/WARNING



DANGEROUS VOLTAGE



DO NOT CONNECT
DAMAGED SUPPLY CORD

WARNING

RISK OF FIRE OR ELECTRIC SHOCK - DO NOT OPEN

WARNING: TO REDUCE THE RISK OF FIRE OR ELECTRIC SHOCK, DO NOT OPEN THE TIME CLOCK. NO USER SERVICEABLE PARTS ARE INSIDE. REPAIRS SHOULD BE COMPLETED BY AUTHORIZED SERVICE PERSONNEL ONLY.



Questions?

Call 800-518-8925

Text 760-278-6623

Email support@trackmytime.com

Visit support.trackmytime.com



Designed, Developed, and Supported by Workwell Technologies, Inc.
© Workwell Technologies, Inc. All rights reserved.
2777 Loker Avenue Suite A Carlsbad CA 92010
workwelltech.com